



Technical features



Technical data

IP Rating	IP65
IK Rating	IK09
Material	High corrosion resistance die-cast copper-free aluminum body
Coating	Polyester powder coating with phosphochromating pre-finish
Screws	Stainless steel
Transformer	Electronic power supply 220/240V 50/60Hz built-in
Gasket	Silicone rubber
Glass	Tempered
Cable gland	Double nickel-plated brass cable gland PG11
Power cable	3 mt. neoprene power cable included

805003-805007

FLASH POLE MAXI

Round pole-mounted floodlight for outdoor installation on a pole diam. 60 mm or 76 mm. Phospho-chromatised and polyester powder coated die-cast copper-free aluminium body, tempered safety glass, moulded silicone gasket and stainless steel screws. Clamp for pole diam 60 mm or 76 mm included. Built-in LED driver 220-240V 50-60Hz, with 8 CREE XP-G3 high-power LED. IP65 rating.

805003

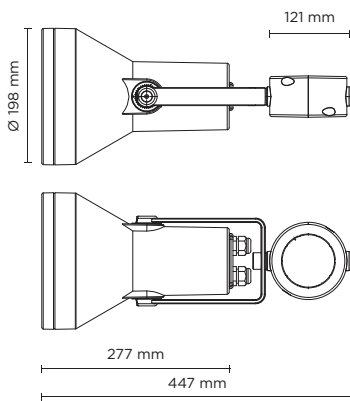

805007

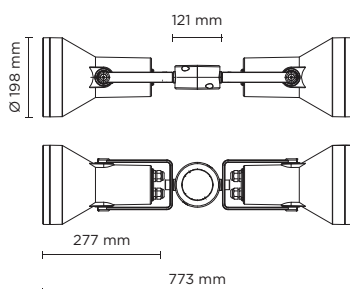





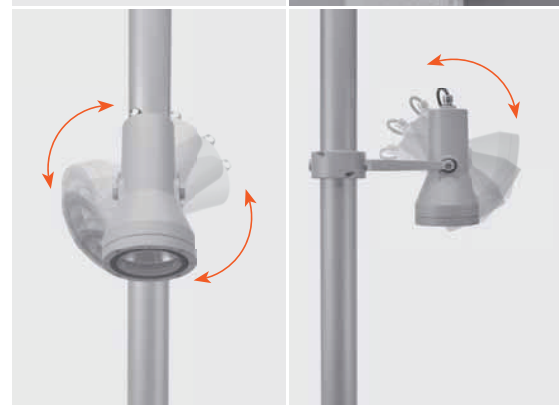

AC-027 Anti-glare visor for hydroflash maxi



Graduated stainless steel insert



LAREN O

805003		SINGLE FLASH POLE MAXI - 12 WATT 220-240V 50-60HZ ELECTRONIC		
light source	light beam options	lumen output (lm)	lumin. efficacy (lm/w)	
3000°K warm-white				
high-power led	 10°	1.152	96.00	
high-power led	 30°	1.095	91.25	
high-power led	 45°	1.040	86.67	
4000°K neutral-white				
high-power led	 10°	1.200	100.00	
high-power led	 30°	1.140	95.00	
high-power led	 45°	1.083	90.25	







Colors options

-  Textured Grey RAL 9006
-  Anthracite Grey RAL 7016
-  Matt Black (on request)

Technical data

Wattage	12 WATT
Light source	NR. 8 CREE "XP-G3" LED
Gross weight	4,00 Kg



805007		DOUBLE FLASH POLE MAXI - 2 X 12 WATT 220-240V 50-60HZ ELECTRONIC		
light source	light beam options	lumen output (lm)	lumin. efficacy (lm/w)	
3000°K warm-white				
high-power led	 10°	2 x 1.152	96.00	
high-power led	 30°	2 x 1.095	91.25	
high-power led	 45°	2 x 1.040	86.67	
4000°K neutral-white				
high-power led	 10°	2 x 1.200	100.00	
high-power led	 30°	2 x 1.140	95.00	
high-power led	 45°	2 x 1.083	90.25	

Colors options

-  Textured Grey RAL 9006
-  Anthracite Grey RAL 7016
-  Matt Black (on request)

Technical data

Wattage	2 x 12 WATT
Light source	NR. 2 x 8 CREE "XP-G3" LED
Gross weight	7,50 Kg



POLES & ACCESSORIES

Full technical details of poles and accessories for poles are available at the end of the catalogue

BURIED POLES	
code	h. mm.
809901	3.500
809902	4.500
809903	5.500
809908	ACC.

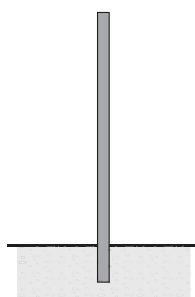

POLES WITH BASE-PLATE	
code	h. mm.
809904	3.000
809905	4.000
809906	5.000
809907	ACC.
809908	ACC.

